

HARVIA[®]

Sauna



A rustic wooden sauna is nestled in a lush forest. The sauna is built from dark, weathered logs and has a steep, moss-covered roof. A thick plume of white steam rises from the roof, partially obscuring the sky. In the foreground, two wooden buckets with handles sit on a wooden bench. The background is filled with dense green foliage and trees, creating a serene and natural atmosphere.

Sauna: A Sensual Pleasure

When you first step into the room, there is a sensation of sweet aroma from the natural woods. You sit back, relax, and let the soft heat envelope you.

You splash a little water over the hot stones and experience the gentle humidity from the steam drifting up into the atmosphere. You start to perspire.

You allow the therapeutic, deep cleansing of your body's pores to begin. You let yourself go, free your mind of daily worries, and feel at peace. You are at once, a part of a 2000 year old Finnish tradition—

The Sauna—that is now becoming a wonderful and necessary part of the American lifestyle

Sauna—Finnish for bath or bathhouse—is a place of tranquillity and rejuvenation. An essential part of Finnish daily life for centuries, the Sauna has steadily gained popularity in the United States since the early 1950's. Today, with our fast paced, hectic lifestyle, the Sauna is more popular than ever. In the Sauna, the skin is deeply cleaned through perspiration, tired muscles are soothed and the mind is eased.

It's a place of sensual pleasure, where everyday hassles and stress give way to peace and relaxation.

With a Harvia Sauna, you'll enjoy the lasting custom craftsmanship, discover the healthy secrets of the Sauna and indulge yourself in its delightful benefits.

The Harvia Sauna. A Tradition For Life.

Sauna is a Finnish original. And Harvia Saunas possess the spirit of centuries-old Sauna traditions like no other.

Unlike steambaths, the Sauna is a blend of high heat (about 160° -180° F) and low humidity (up to about 25%), creating an environment where the body cleanses itself naturally through perspiration. Built in a well insulated room and lined with untreated kiln dried softwood to absorb humidity and keep the atmosphere dry, the Sauna is heated by igneous rocks distributed among the elements of a special Sauna heater. The rocks store and soften the heat and produce steam when water is poured over them to allow you to regulate your own humidity. This combination of heat and humidity thoroughly cleans the body and softens the skin, while relieving aches and pains.

Harvia Saunas are constructed with the finest Western Red Cedar, Alaska Yellow Cedar, vertical grain Redwood or Western Hemlock available. Kiln dried to within 8-11% moisture content, Harvia uses only clear 1" x 4" boards to prevent shrinkage and warpage.

When you choose a Harvia Sauna, you choose a product recognized for its superior quality, advanced technology and beautiful style. Dedicated to the Sauna's philosophy of health, relaxation and physical well-being, Harvia Saunas are an investment in a healthier lifestyle.



Harvia Oy is the largest manufacturer of Sauna heaters in the world. Founded by the "father" of the modern Finnish Sauna heater, Tapani Harvia in 1951, Harvia Oy has built a solid reputation on quality, dependability and safety second to none. Located in Muurame, Finland, the new, 135,000 square foot plant is the most modern and technologically advanced factory in the Sauna industry. Utilizing developments from constant research, as well as computerized robotics and advanced testing methods, the family owned Harvia Oy is poised to continue its market dominance and commitment to customer satisfaction and high quality products into the 21st Century.

Harvia Sauna. For Ultimate Relaxation.



Harvia Sauna offers the perfect place to relax. The soft heat and gentle moisture eases tension and anxiety, leaving you calm and rejuvenated. Interior of FPF68 with standard Western Red Cedar and 4 benches.

Designing a Harvia Sauna for your needs requires some pre-planning. You should choose a space large enough to sit and recline comfortably. Rectangular or square Saunas utilize the space more efficiently than odd angled designs. (See Figure 1 Plan A and B comparison.) You should also install your Sauna close to a shower. Because the Sauna is a deep cleansing bath that opens the pores and flushes out the body's impurities, the shower will allow you to wash and rinse off, while cooling down.

In addition, two levels of benches are extremely important in a good Sauna. The top bench allows you to take advantage of the rising heat, while the lower bench is used as a step or a seat at a lower temperature. Allow 2' of bench space per person for seating, and 6' of bench space to accommodate a reclining bather. Bench width should be 20" for both upper and lower benches.

Sauna room height should be no more than 7' from the finished floor and no less than 6' 2". These dimensions maximize heat at bench and head levels, without wasting energy and building material. Figure 2 shows the variance of temperature at different levels in the Sauna room.

If you have the space, a small dressing room with a cooling bench or benches should be located outside the Sauna. It will give you a place to relax and enjoy the wonderful "after Sauna" feeling.

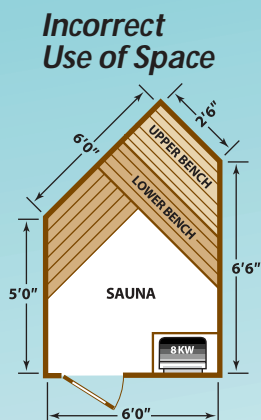

Plan A: Wasted Space

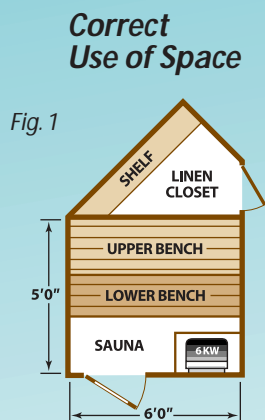

Plan B: Good Use of Space

Fig. 1

Ceiling Height Temperature Comparison

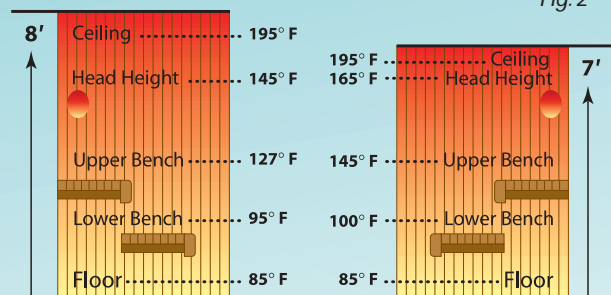

Incorrect Ceiling Height

Correct Ceiling Height

Fig. 2

Since good air circulation is important to the efficiency of the Sauna, and the comfort of the bather, you'll want to have a lower, fresh air vent and an upper exhaust vent. Placed about 4" from the floor and close to the heater, the fresh air vent provides oxygen for a comfortable atmosphere and enables the heater to function better. The exhaust vent can be placed as low as 24" from the floor or as high as 6" from the ceiling. When both vents are open, air changes 4 to 6 times per hour. When heating the Sauna, close the upper vent to heat the Sauna faster. (See figure 3.)

Sauna doors always open out and should be 24" wide to prevent unnecessary heat loss and warpage. However, to meet ADA requirements, 36" handicapped doors can be specified, if the Sauna is large enough to accommodate the movement of a wheelchair. Metal doors and door handles should not be used, to avoid burns.

Do not put a shower in the Sauna room. Because chlorinated humidity will rust hinges on the door, and cause warping, a Sauna door should not open directly into a shower room.



In a Harvia Sauna, you can indulge yourself in pure Sauna pleasure.



Sauna, pronounced "sow (like wow) nah," is the only Finnish word in the English dictionary, and it means "bath" or "bathhouse." Interior of FPF56 with standard Western Red Cedar and 2 benches.

Ventilation Requirements

Fig. 3

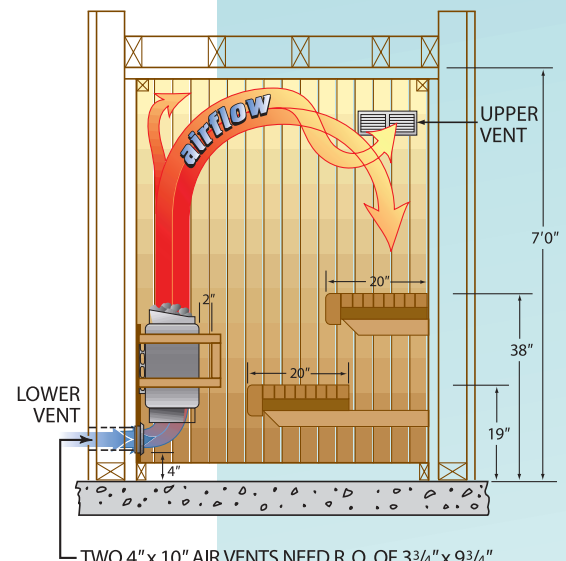

NOTE: Above diagram shows typical vent placement only. Vent location may vary from room to room. Harvia strongly suggests one upper and one lower vent for bather comfort and proper Sauna heating. Vents are recommended but not required for any health or safety reasons.

Harvia Precut Sauna Packages. Custom Cut to Your Specifications.

Whether you choose to design your own floor plan, or order one of the many pre-cut floor plans available from Harvia, you can be assured of quality and craftsmanship. Each package is custom cut to carefully match the specifications, and easy-to-follow building plans are included.

Harvia precut Sauna packages come in several standard sizes, as well as in any custom size you wish. You must provide framing, insulation and the proper water-proof flooring at the building site. Simply supply a sketch of your floor plan, and we'll do the rest. Harvia precut packages include ceiling and wallboards cut to the necessary lengths, pre-assembled benches, a prehung door, Sauna heater and controls, and other essential room parts.



Super Dek flooring for easy cleaning and safety.

Manufactured in many standard or custom sizes, **Harvia Precut Sauna Packages** are easy to build. You frame and insulate the space, we provide the interior parts and materials. Only standard carpentry skills are needed for installation.

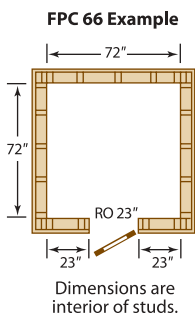

**Boards are cut for horizontal installation.
Benches are nailed from the bottom to avoid protruding nail heads.**

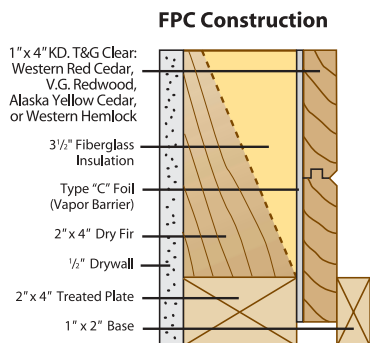

FPC PACKAGES INCLUDE:

Precut Wall & Ceiling Boards: Choice of 1" x 4" (finished 1 1/16" thickness) clear Western Red Cedar, clear V.G. Redwood, clear Western Hemlock, or clear Alaska Yellow Cedar. Certified, kiln dried T&G, cut to size for horizontal installation — full wall length.

Assembled Benches: Clear V.G. S4S kiln-dried 2" x 2" tops with 1/2" spacing and 2" x 4" facing. (Superior in design and strength.)

Prehung Glass Door: 2'0" x 6'8"; V.G. Douglas Fir rails to reduce warpage: tempered, thermopane glass unit for spacious open look; Redwood or Hemlock jamb; stoppers, interior casing and threshold. Hardware includes three 4" x 4" brass plated butt hinges, ball catch to keep door securely closed, two wooden door pulls.

Assembled Heater Fence: 2 sided or 3 sided.

Assembled Bench(es) Headrest/Backrest

Trim and Base

Super Dek: Per specs pg 14. Covers walking area of floor only.

Harvia Sauna Heater

Peridotite Stones

Control/Contactor Panel: Located on heater or exterior Sauna wall.

Light: Wall mounted, vapor-proof.

Vents: Two sets. You install in upper and lower wall areas.

Accessories: Wooden thermometer #0301K, wooden bucket #102 with plastic liner, wooden dipper #106/40, plexiglass bathing sign.

Instructions for Assembly/Building

Nails and Screws

STANDARD FLOOR PLANS FOR PRECUT & PREFAB SAUNAS

Dimensions for floor plans shown are exterior of our prebuilt panels for FPF prefab, modular Saunas and interior of your framing for FPC precut Saunas. We precut to size. Standard heater models are listed at the bottom of each diagram.

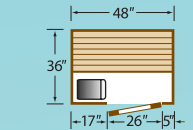

FPC 34 or FPF 34
Seats 1 Person
JM17 or JM20 Heater

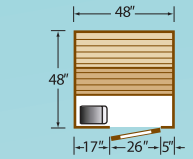

FPC 44 or FPF 44
Seats 2 People
JM30 Heater

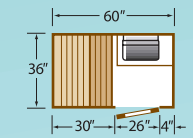

FPC 35 or FPF 35
Seats 1 Person
KIP30B Heater

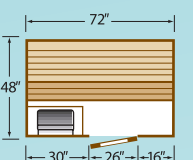

FPC 46 or FPF 46
Seats 3 People
KIP45B Heater

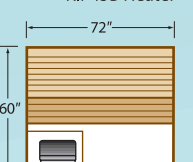

FPC 56 or FPF 56
Seats 3 People
KIP60B Heater

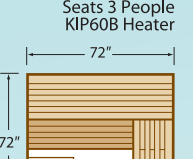

FPC 66 or FPF 66
Seats 4 People
KIP60B Heater

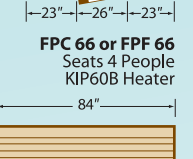

FPC 812 or FPF 812
Seats 12 People
K150 Heater

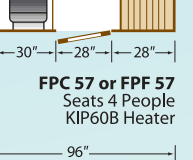

FPC 810 or FPF 810
Seats 8 to 9 People
K120 Heater

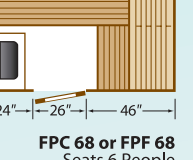

FPC 88 or FPF 88
Seats 7 to 8 People
K90 Heater

FPC 68 or FPF 68
Seats 6 People
KIP80B Heater



*Clear 1" x 4"
Western Red Cedar
(standard wood)*



*Clear 1" x 4"
V.G. Redwood
(optional)*



*Clear 1" x 4"
Western Hemlock
(optional)*



*Clear 1" x 4"
Alaskan Yellow Cedar
(optional)*

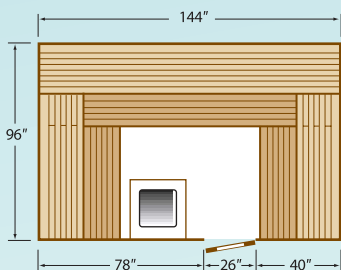

FPC 812 or FPF 812
Seats 12 People
K150 Heater

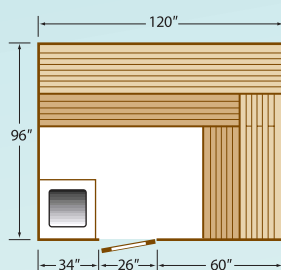

FPC 810 or FPF 810
Seats 8 to 9 People
K120 Heater

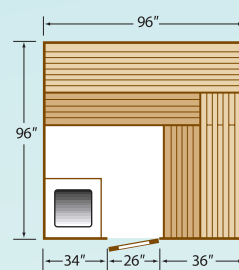

FPC 88 or FPF 88
Seats 7 to 8 People
K90 Heater

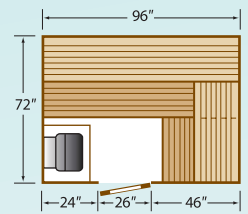

FPC 68 or FPF 68
Seats 6 People
KIP80B Heater

Harvia Modular Saunas. High Quality, Easy To Assemble.



Each Harvia Modular Sauna is designed to give you endless hours of pure Sauna satisfaction. Engineered for fast, effortless installation, you can erect your Harvia Modular Sauna on any hard surfaced, washable, waterproof floor. Using our unique interlocking system, the framed and insulated wall sections (about 2' wide) are easily assembled in a matter of minutes without using nails, screws or bolts. Built on a 2" x 4" base, the interior wall sections are paneled with 1" x 4" clear Western Red Cedar (standard) or your choice of 3 other woods. Exterior walls are paneled with ruff sawn Mahogany (standard), or optional 1/2" x 4" Western Red Cedar. All electrical conduit is sealed inside the walls, and the heater junction box, light R.I. box, and light switch box (or optional control box) are premounted in wall sections.

An easy to follow assembly video is included to take the mystery out of installing your Harvia Modular Sauna. Plus each Sauna has been pre-fitted prior to shipping, so you can be assured of precise fits and trouble free construction.

Our unique locking system guarantees a fast, easy assembly, strong installation and custom look.



Model FPF665S—5-sided with standard cedar interior and exterior on 3 front walls. Two 12" x 60" sidelights. KIP60B heater.



Model FPF56 with standard ruff sawn Mahogany exterior and clear glass door.

Country Line Saunas are made of individual logs—1.78" thick. These rustic spruce log Saunas are imported from Finland and are available in 3 sizes:
 CL1620 64" x 81" x 83 1/4" h
 CL2020 or CL2020-5S (5-sided) 81" x 81" x 83 1/4" h
 CL2222 or CL2222-5S (5-sided) 91" x 91" x 83 1/4" h



Model FPF56 with standard cedar interior, clear glass door; optional cedar exterior, cedar vent, 4' cedar cooling bench.

PFF SAUNA SPECIFICATIONS

Framing: 2" x 2" Oregon Douglas Fir. Frame fastened with galvanized fasteners.

Insulation: R11 (3 1/2") Fiberglass with foil back for walls and ceiling.

Vapor Barrier: Type C Building Foil for walls and ceiling.

Base: 2" x 4"

Exterior Siding: Ruff-sawn 1 1/2" Mahogany plywood. Option of 1/2" x 4" T&G Western Red Cedar.

Interior Paneling: 1" x 4" (1 1/8" thickness) kiln-dried, clear Western Red Cedar (standard), clear V.G. Redwood, clear Alaska Yellow Cedar or clear Western Hemlock—T&G with small v joint for neat appearance.

Exclusive Concealed Locking System: Locks walls together. Provides greatest strength and neatest appearance.

Benches: S4S 2" x 2" tops, with 1/2" spacing. S4S 2" x 4" facing. Eased edges eliminate sharp angles and splinters. All fasteners are applied from the bottom, eliminating nail holes, and exposed nails that will burn the bather.

Head/Back Rest(s): For upper bench(es). Tapered 20" x 14 1/2"

Prehung Door: V.G. Douglas Fir rails. Fir, Hemlock, or Redwood jamb, stoppers, casing and threshold. Tempered, thermopane glass unit. Hardware includes three 4" x 4" brass plated butt hinges and brass plated ball catch, 2 wooden door pulls.

Heater Fence: (For safety) 2" x 4" and 2" x 2" material.

Super Dek: Removable 12" x 12" flooring squares that lock together for walking area of Sauna. Washable, sanitary, non-skid synthetic material.

Vents: Lower vent neatly cut into room base. Upper supplied for precut space

Light: Vapor-proof, wall mounted P5511.

Trim: For exterior.

Harvia Sauna Heater: Wall model or floor model.

Controls: Located on heater or exterior Sauna wall. Includes 60 minute timer.

Peridotite Stones: From Finland. Igneous stone for best heat retention and safety.

Standard Accessories: Thermometer #0301K, #102 wooden bucket and liner, wooden dipper #106/40, light switch, plexiglass bathing sign.

Installation Video: Easy to follow assembly instructions.

PFF Construction

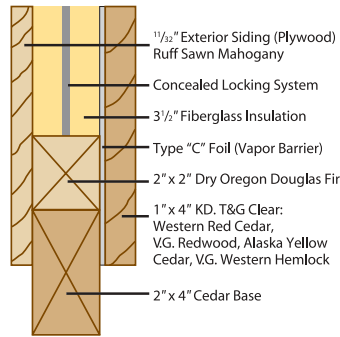

Harvia PPF34 Prefab Sauna
3' x 4' exterior dimension
with 6'6" ceiling, 1" x 4"
Western Red Cedar interior,
120 v JM20 or JM17 heater
(electrician can adapt
for wall plug), 1 bench,
clear glass door.
Options shown:
1/2" x 4" Western Red Cedar
Front with horizontal,
vertical or diagonal boards.



Harvia PPF445S 5-sided Prefab Sauna is standard with full glass door, 2 benches, Western Red Cedar interior and three front exterior sides of cedar. Sidelight is optional.



FPF34—1 bench.

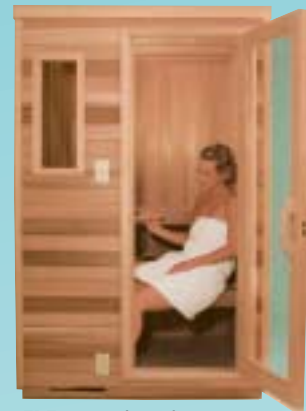

FPF44—2 benches. JM30 240 v heater. Options: cedar exterior, front sidelight.

Solid Line Saunas Imported from Finland



Made with unique system of laminated spruce logs (1 1/8" thick) with growth rings back to back to equalize and prevent cupping and warping. Available in three sizes in natural or painted (two-tone stain) finish. Model shown is SL1919N natural.

Solid Line Sauna Floor Plans:

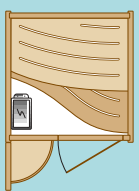

Model SL1010
52 3/4" x 38" x 79 1/4"
JM20 heater.

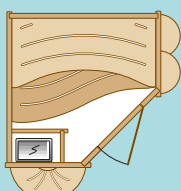

Model SL1515
57 1/2" x 56 3/4" x 79 1/4"
KIP45B heater.

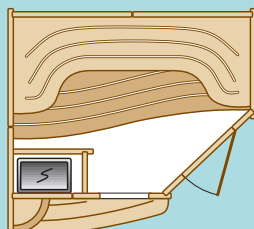

Model SL1919
75" x 75 1/4" x 79 1/4"
KIP60B heater.

Harvia Sauna Heaters. Soothing, Soft Heat.



Model KIP - W



Model KIP - B

Reflections—
Beautiful scenic options—may be ordered for KIPB and KIPW models only.

- RNL Reflections**
- Northern Lights**
- RMS Reflections**
- Midnight Sun**

It's no wonder Harvia Sauna heaters enjoy a world wide reputation. Engineered with the latest in Sauna heater technology, Harvia heaters are designed to deliver maximum performance and long life with greatest heating efficiency. Manufactured with high quality materials for increased dependability and durability, the sleek, modern lines, and compatible silver/gray color, will complement your Sauna and optimize your Sauna experience.

In the Harvia heater, special peridotite stones fill the entire body cavity and are directly heated by stainless steel elements. The igneous stones filter the 1400° F heat and emit a soft, pleasant aura of high heat rather than a harsh blast from unfiltered elements. The directly heated stones also produce the best steam when water is ladled over them, to raise the Sauna's humidity level. In addition, the stones retain heat, reducing on/off cycling of the heater for greatest efficiency and economy.

The Harvia Sauna heater is a combination of 21st Century technology, superior craftsmanship and age-old tradition. It is the heart of the Sauna and designed to give you endless hours of pure Sauna pleasure.



Model KV



Model K



Ever Ready®
 Model AV

MODEL KIP - B 50# Stones

- Wall Model. Size: 16" w x 11" d x 24" h
- Superior quality Sauna heater.
 - **Built-in controls with silent 60-minute timer and thermostat.**
 - **Exclusive programmable time clock allows Sauna to be preset 1 to 8 hours in advance of operation.**
 - Controls can also be side mounted.
 - Long-lasting stainless steel interior and top.
 - Glossy baked enamel casing.
 - Welded unibody casing with compressed metal design for greater strength and durability.

MODEL KIP - W 50# Stones

- Wall Model. Size: 16" w x 11" d x 24" h
- Superior quality Sauna heater.
 - **Requires wall control (and contactor, if needed).**
 - Long-lasting stainless steel interior and top.
 - Glossy baked enamel casing.
 - Welded unibody casing with compressed metal design for greater strength and durability.

TOPCLASS KV 50# Stones

- Wall Model. Size: 18" w x 10" d x 25" h
- Top-of-the-line heavy-duty heater.
 - Lighted control panel with 60 minute timer and delayed 8 hour time clock can be mounted on right or left side.
 - Heavy-duty stainless steel and baked enamel.

MODEL K 100# Stones

- Commercial Floor Model. Size: 17" w x 20" d x 26" h
- Requires wall control and contactor.
 - **Deluxe stainless steel interior and exterior.**
 - Welded unibody casing with compressed metal design for greater strength and durability.

EVER READY® AV 250# Stones

- Floor Model Size: 20" w x 21" d x 37" h
- Ready whenever you are, the Ever Ready stays on all the time.
 - Illuminated comfort control panel is easy to read. Includes vacation mode on-off switch.
 - Uses only 250 watts of power.
 - 4 or 6 kw booster for highest heat.
 - ADEX-award winning design incorporates space age microceramic insulating technology.
 - Silent operation.
 - **Instantly creates softest heat and outstanding steam production.**
 - Heavy-duty stainless steel and baked enamel.
 - Needs no fence, outside casing is safe to touch.



Comfort Control panel on all KV, JM, AV heaters.

MODEL JM 20# Stones

- Wall Model. Size: 12" w x 9" d x 25" h
- Compact space saver for small Saunas.
 - The only heater with it's own built-in heater fence.
 - Lighted control panel with 60 min. timer is safe and easy to use. Located at the top of the heater, it can be mounted on the left or right.
 - Heavy-duty stainless steel and baked enamel.
 - Removable tray at the bottom to catch excess water.



Model JM

WOODBURNING SAUNA STOVES FROM FINLAND

Harvia Oy woodburning stoves are perfect for outdoor Saunas or use in remote areas without adequate electricity. Shipping weight is 132 lbs, plus 100 lbs, of igneous rock.

Minimum room size: 6' x 8'
Maximum room size: 8' x 10'

HARVIA 20ST
Size: 17" w x 29" h x 20" d
Stainless steel and black galvanized metal.

HARVIA 20 Super
Size: 17" w x 29" h x 20" d
Galvanized metal—red and black.

HARVIA 20ES
Size: 17" w x 29" h x 24 1/2" d
Includes 5 gal. water tank inside top front.



Model 20ST

Model 20 Super Model 20ES (Shown)

*Wood Stove Surround for any of our wood stoves. Galvanized metal—3 walls and floor.
Ext. dimensions: 22" w x 34" d x 40 1/2" h
Int. floor dimensions: 19 1/2" w x 31 1/2" d x 2" h (with adjustable leg leveler)*



Control



Contactor



Solid State Control

HARVIA CONTROLS

Designed for safe and easy operation, Harvia heat controls feature shock resistant and sure grip control knobs, durable Lexan face plates with permanent lettering and molded plastic trim plates.

Controls are made in the U.S.A. and include thermostat, 60 minute timer, light switch and indicator light.

F2 control does not include a 60 minute timer. It can be used with any of the Harvia heaters with the use of a contactor, and a 24 hour time clock.

F1 T 3 3/4" w x 9 1/4" h x 3 1/2" d

F2 and F2 T 3 3/4" w x 9 1/4" h x 2 1/2" d

HARVIA CONTACTORS

See chart for use with proper heater and control. Made in the U.S.A.

FL402 and FL303 6" w x 8" h x 4" d

FL404 and FL503 8" w x 12" h x 4" d

SOLID STATE CONTROL

HT10 and HT10C 5 1/4" w x 4" h x 1 1/2" d

This high-tech control can be located up to 20 feet away from the Sauna. Pre-program the Sauna start, heat-on time, temperature and shut down. The HT10 model is optimized for residential use. It has a vacation mode option to override the daily program. The HT10C model for commercial operation has a temperature preset and lock to prevent tampering. *The control must be used with a separate contactor: HT402 or HT404 for 240V 1PH operation, or HT303 or HT503 for 208V 3PH operation. 8" w x 12" h x 4" d*

See page 11 for heater specification charts.

Heater Specifications.

MODEL KIP-B WITH BUILT-IN CONTROLS

Heater Model Number	KIP30-B1	KIP45-B1	KIP60-B1	KIP80-B1
Minute-Max Cu. Ft.	84-130	100-210	170-300	250-425
Watts	3,000	4,500	6,000	8,000
Amps	12.5	18.8	25	33.3
Voltage	240	240	240	240
Phase	1	1	1	1
Wire Size 90°C Copper	12	10	10	8
Control Model Number	Built-in	Built-in	Built-in	Built-in
Contactor Model Number	None	None	None	None
Shipping Weight	40	40	40	40

50# of peridotite stones shipped in separate box.

Residential model only.

MODEL KIP-W WITH WALL CONTROLS

Heater Model Number	KIP30-W1	KIP45-W1	KIP60-W1	KIP80-W1	KIP30-W3	KIP45-W3	KIP60-W3	KIP80-W3
Minute-Max Cu. Ft.	84-130	100-210	170-300	250-425	84-130	100-210	170-300	250-425
Watts	3,000	4,500	6,000	8,000	3,000	4,500	6,000	8,000
Amps	12.5	18.8	25	33.3	8.3	12.5	16.7	22.2
Voltage	240	240	240	240	208	208	208	208
Phase	1	1	1	1	3	3	3	3
Wire Size 90°C Copper	12	10	10	8	14	14	12	10
Control Model Number	F1T	F1T	F1T	F2T	F2T	F2T	F2T	F2T
Contactor Model Number	None	None	None	FL402	FL303	FL303	FL303	FL303
Shipping Weight	40	40	40	40	40	40	40	40

50# of peridotite stones shipped in separate box.

MODEL KV WITH BUILT-IN CONTROLS

Heater Model Number	KV 45	KV 60	KV 80
Minute-Max Cu. Ft.	100-210	170-300	250-425
Watts	4,500	6,000	8,000
Amps	18.8	25	33.3
Voltage	240	240	240
Phase	1	1	1
Wire Size 90°C Copper	10	10	8
Control Model Number	Built-in	Built-in	Built-in
Contactor Model Number	Built-in	Built-in	Built-in
Dimension DxWxH	10x18x25	10x18x25	10x18x25
Shipping Weight	41	43	44

50# of peridotite stones shipped in separate box.
4# rock guard shipped in separate box.

Residential model only.

MODEL K WITH WALL CONTROLS

Heater Model Number	K90-F1	K105-F1	K120-F1	K150-F1	K90-F3	K105-F3	K120-F3	K150-F3
Minute-Max Cu. Ft.	300-525	390-600	440-750	560-1050	300-525	390-600	440-750	560-1050
Watts	9,000	10,500	12,000	15,000	9,000	10,500	12,000	15,000
Amps	37.5	43.8	50	62.5	25	29.2	33.3	41.7
Voltage	240	240	240	240	208	208	208	208
Phase	1	1	1	1	3	3	3	3
Wire Size 90°C Copper	6	6	4	4	10	8	8	8
Control Model Number	F2T	F2T	F2T	F2T	F2T	F2T	F2T	F2T
Contactor Model Number	FL404	FL404	FL404	FL404	FL503	FL503	FL503	FL503
Shipping Weight	60	60	60	60	60	60	60	60

100# of peridotite stones shipped in 2 separate boxes.

MODEL AV WITH BUILT-IN CONTROLS

Heater Model Number	AV 4	AV6
Minute-Max Cu. Ft.	170-300	200-400
Watts	4,400	6,500
Amps	18.3	27
Voltage	240	240
Phase	1	1
Wire Size 90°C Copper	10	8
Control Model Number	Built-in	Built-in
Contactor Model Number	None	None
Dimension DxWxH	21x20x37	21x20x37
Shipping Weight	91	91

250# of peridotite stones shipped in 5 separate boxes.

Residential model only.

MODEL JM WITH BUILT-IN CONTROLS

Heater Model Number	JM 17	JM 20	JM 30
Minute-Max Cu. Ft.	42-64	44-79	68-138
Watts	1,700	2,000	3,000
Amps	14.2	16.6	12.5
Voltage	120	120	240
Phase	1	1	1
Wire Size 90°C Copper	12	12	12
Control Model Number	Built-in	Built-in	Built-in
Contactor Model Number	None	None	None
Dimension DxWxH	9x12x25	9x12x25	9x12x25
Shipping Weight	47	47	47

21# of peridotite stones shipped in heater box.

Residential model only.



HEATER GUARD ASSEMBLY

For safety, each Sauna heater should have a 2- or 3-sided wood guardrail that is mounted on the wall 2" to 2½" from the heater. Harvia wall mounted heaters and guardrail need a 16" x 26" space and floor models need a 30" x 30" space. These dimensions satisfy the minimum requirements for heater clearance from wall surfaces. Built of 2" x 4" and 2" x 2" lumber.

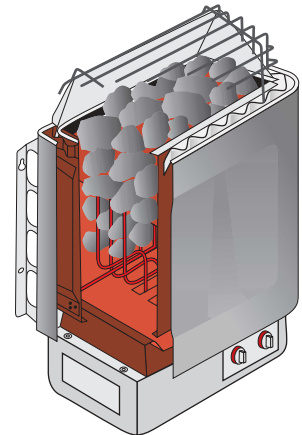

Harvia heaters are tested and designed for the perfect combination of stone quantity, proper airflow, and steam output. The directly heated stones filter and reduce the electro-magnetic field for safe and therapeutic bathing.

When ordering, specify the elevation above sea level at your location. If a fire sprinkler is required, the head should be set at 275°F (or higher) and should not be located over the Sauna heater.

All Harvia Sauna heaters are UL tested and listed.

Harvia Doors Set the Standard of Excellence.

Harvia Sauna doors are truly doors of distinction. Unlike other Sauna doors, Harvia glass insert doors are manufactured with solid, vertical grain Douglas Fir rails, or with optional solid California Redwood rails. Tempered for safety, the 16" x 60" clear, hermetically sealed insulated glass is standard in the Harvia FPC and FPF Sauna packages.

Exclusive Etched Glass Option

Custom etched by Northwest artists, the classic Sauna design is available in a positive image (glass is clear and design is frosted), or a negative image (glass is entirely frosted except for the design) for privacy. Harvia etched doors add a custom touch to your Sauna.

Ordering Instructions

When ordering individual doors, please specify model:

- FGD** – Door only, does not include jamb and hardware.
- FGD-R** – Prehung with right hinge, door opens out to right.
- FGD-L** – Prehung with left hinge, door opens out to left.

FGD-R and FGD-L doors come complete with jamb, threshold, three brass plated butt hinges, brass plated ball catch (for closure) and two wooden door pulls. Standard Harvia glass doors are 24" x 80" with a 4³/₄" jamb and a standard rough opening (RO) of 26" x 82".

Options:

- 36" x 80" to meet ADA specification (38" x 82" RO).
- 30" x 80" doors (32" x 82" RO).
- 22" x 80" doors (24" x 82" RO).
- Custom jambs may be ordered in any size.

(Remember: Hinge placement is determined by standing outside the Sauna room while facing the door. If you want the door to open to the right, it will have hinges on the right side and vice versa.)

All Glass Imported Doors

Finest Finnish bronze tinted glass.
 Square: Right Hinge, 3¹/₂" jamb needs RO of 27¹/₄" X 82¹/₂" or 27¹/₂" X 74³/₄".
 Arched: Right Hinge, needs RO of 27¹/₄" X 74³/₄".



Negative Etched Sauna Design

Standard Fir rails.
 FGD-R right hinge shown.



Positive Etched Sauna Design

Standard Fir rails.
 FGD-R right hinge shown.



Obscure Glass

Totally frosted for privacy.
 Standard Fir rails.
 FGD-L left hinge shown.



Lighthouse Etched Glass Design

Standard Fir rails.
 FGD-L left hinge shown.



Mt. Hood Etched Glass Design

Optional Redwood rails.
 FGD-L left hinge shown.



Multnomah Falls Etched Glass Design

Standard Fir rails.
 FGD-R right hinge shown.



Complete Your Sauna with Harvia Accessories.



Essential handcrafted wooden extras and beautiful copper accessories add authentic "Old World" charm to your Sauna.

WALL ACCESSORIES

- 603A 5-peg pine towel hanger 15 1/4" long
- 442 4-peg cedar towel hanger 14 3/4" long
- 3644 Copper Sauna sign
- 216K Birch bark Sauna sign
- 139K Round pine thermometer 5 1/2" diam.
- 0307K Raindrop pine thermometer
- PBS Plexiglas bathing sign
- 150V Pine bucket shape thermometer
- 030K Rectangular pine thermometer with Sauna bucket/birch leaf picture
- 305K Heart shaped pine thermom./hygrom.
- 250K Deluxe pine/glass thermometer
- 280K Deluxe pine/glass thermom./hygrom.
- 210K Pine and glass Sauna sand timer
- 5355 Chrome/glass thermometer 4" diam.
- 4355 Chrome/glass hygrometer 4" diam.
- 5498 Chrome/glass thermom./hygrom. 5" diam.
- 5499 Chrome/glass thermom./hygrom. 7" diam.
- 1440 Round copper thermometer 5 1/2" diam.

UPPER BENCH ACCESSORIES

- VIC-S Birch soap (100 g)
 - VIC-SH Birch shampoo (200 ml)
 - VIC-C Birch conditioner (200 ml)
 - VIC-SG Birch shower gel (200 ml)
 - VIC-BL Birch body lotion (200 ml)
 - VIC-SR Birch soap on a rope (200 g)
 - VIC-GS Birch glycerin soap (200 g)
 - 490-128 Two brushes with 2-peg hanger
 - 3434 Door handles (Western Red Cedar, Redwood, Alaska Yellow Cedar)
 - 085 Ball catch for door
 - V5 Cedar Sauna vents 4" x 10"
 - 108N Wooden pail (2 gal.)
 - 106/50 Wooden dipper 19"
 - 101N Wooden bucket (1.84 gal.)
 - 100L Plastic bucket liner
 - 3465 Light copper bucket (1 gal.)
 - 3455 Light copper dipper 19 1/2"
 - 3453 Hammered copper dipper 15"
 - 102N Bottomless bucket (1 gal.) and liner
 - 106/40 Wooden dipper 16"
 - AR-5 Set of 5 aromas with wooden holder
- AR-5 AROMAS: (1.8 oz)**
- AR-E Eucalyptus
 - AR-C Citrus
 - AR-B Birch
 - AR-CH Cherry
 - AR-D Dandelion
- Also available individually.

SAUNA BENCH MAT (Green)

HARVIA BENCH MAT (Red)

- V10 Metal Sauna vents 4" x 10"
- FDH Door handles (Redwood, Douglas Fir)

LOWER BENCH ACCESSORIES

- SD12 Interlocking Super Dek flooring 12"sq. (red or tan)

HARVIA AROMAS: (500 ml)

- 50011 Eucalyptus
- 50012 Citrus
- 50013 Birch
- 108S Wooden pail with steel liner (2 gal.)
- FV Video
- 100B Burned wooden bucket (1 gal.)
- 079 Tapered headrest (cedar) 19 3/4" x 14 5/8"
- P5511 Vapor proof wall light
- 120V Pine door handle with towel hook 12"
- 080 Pine door handle 10"
- HC Harvia logo baseball cap
- 50014 Pine
- 50015 Traditional Smoke
- 50016 Oriental



Model FPF66 with standard cedar interior, clear glass door; optional cedar exterior and cedar vent.

Harvia Specifications For Architects/Contractors

GENERAL CONTRACTOR PROVIDES:

Framing: Walls and ceiling. Dry, construction grade 2 x 4, 16" center Douglas Fir. Use pressure treated plates against concrete.

Ceiling: 7'0" from finished floor to ceiling joists.

Door: Roughed in at 26" x 82". Must open out.

Insulation: Walls and ceiling—R11 foil faced fiberglass batts.

Drywall: 5/8" firewall. (Use only if required by building code.)

Vapor Barrier: Type C building foil over insulation or drywall on walls and ceiling. (If foil faced fiberglass is not used.)

Flooring: Hard surfaced, waterproof concrete, ceramic tile, heavy-duty seamless vinyl.

Floor Drain: Recommended for new construction. Essential for commercial and public Saunas.

Exterior Walls: Drywall, paneling, tile etc., and exterior painting, door finishing etc.

ELECTRICAL CONTRACTOR PROVIDES:

(Must be licensed and bonded)

Rough-in: Sauna controls, heater and room light per Harvia wiring diagram in control box or heater box.

Hook-up: Per Harvia wiring diagram for controls, heater and light.

(See pg. 11 for wire size, amperage etc.)

Note: Use Copper Wire Only.

HARVIA SAUNA CONTRACTOR PROVIDES:

Walls and Ceiling: 1" x 4" select, certified, kiln-dried (moisture content not exceeding 11%) T&G, v joint, clear Western Red Cedar boards. All boards blind nailed with 5p galvanized, hot dipped nails, or power stapled with galvanized staples.

Benches: Clear S4S kiln-dried 2" x 2" tops with 1/2" spacing and 2" x 4" facing. Glued and fastened with exposed nails countersunk. Fasten bench tops from the bottom to eliminate exposed metal.

Doors: FGD 2'0" x 6'8" of solid V.G. Douglas Fir rails. Clear, hermetically sealed tempered double glass (16" x 60"), with interior casing, jamb and threshold.

Door Hardware: (3) 4" x 4" butt hinges. Ives ball catch—MP 347B3. (2) wooden door pulls—080 or FDH.

Vents: (2) 4" x 10" louvered V10 for upper and lower wall placement.

Flooring: Non-skid, sanitary Super Dek interlocking 12" squares for walking area of Sauna. Terra Cotta or tan color. Antimicrobial—prevents mold, mildew and odor causing bacteria.

Light: Vapor proof Progress P5511. Satin finish cast aluminum. Wall mounted.

Sauna Heater: Harvia model per room cubic footage and voltage requirements.

Heater Fence: 2" x 4". Placed 2" to 2 1/2" away from heater.

Temperature Control/Contactor: Panel appropriate for heater. (See chart pg. 11)

Accessories: See page 13.

Stones: Peridotite—heat tested, igneous imported from Finland.

Precut and Prefab Saunas: Per specifications.

Warranty: 1 year on room materials and workmanship. 5 year limited warranty on Harvia Sauna heaters when installed according to Harvia specifications and wiring instructions.

MAINTENANCE

You'll love the fact that Harvia Saunas and Sauna heaters are easy to maintain and require very little care. To keep your Sauna sanitary and odor-free, use a basic household cleaner such as Pine Sol for cleaning the floor and occasionally scrub the benches with mild soap. Over time, perspiration will darken or stain the wood. A light sanding will help restore its beautiful appearance.

Do not use sealers, paint, or varnish on interior wood. The high heat of the Sauna could release harmful, toxic vapors.

Load Strength of Western Red Cedar Boards

Max Load (lbs.)	0	500	1000	1500	2000
2 x 4	1809 lbs. Harvia Bench Facing				
2 x 2	902 lbs. Harvia Bench Tops				
1 x 4 S4S	605 lbs. Competitors Bench Tops				
1 x 4 T&G	572 lbs. Harvia FPC Wallboard				
7/16 x 4 T&G	364 lbs. Harvia FPF Exterior				
1/2 x 4 T&G	341 lbs. Competitors FPC Wallboard				

Independently Tested by Louisiana-Pacific Corporation Advanced Technology Center



HARVIA[®]

Sauna

Harvia Sauna. Experience the sensual
pleasure of authentic Finnish Sauna.
For more information call:

HARVIA SAUNA U.S. A.
14010-B S.W. 72nd Avenue
Portland, Oregon 97224-0088
1-800-665-7170 fax 503-684-1120

© Copyright 2002, Harvia Sauna U.S.A. We reserve the right to make technical changes.